



# SOLOMIX 3

*Feed mixers with  
three vertical augers*

Trioliet. Invents for you.



**A SUITABLE SOLUTION  
FOR EVERY COMPANY**





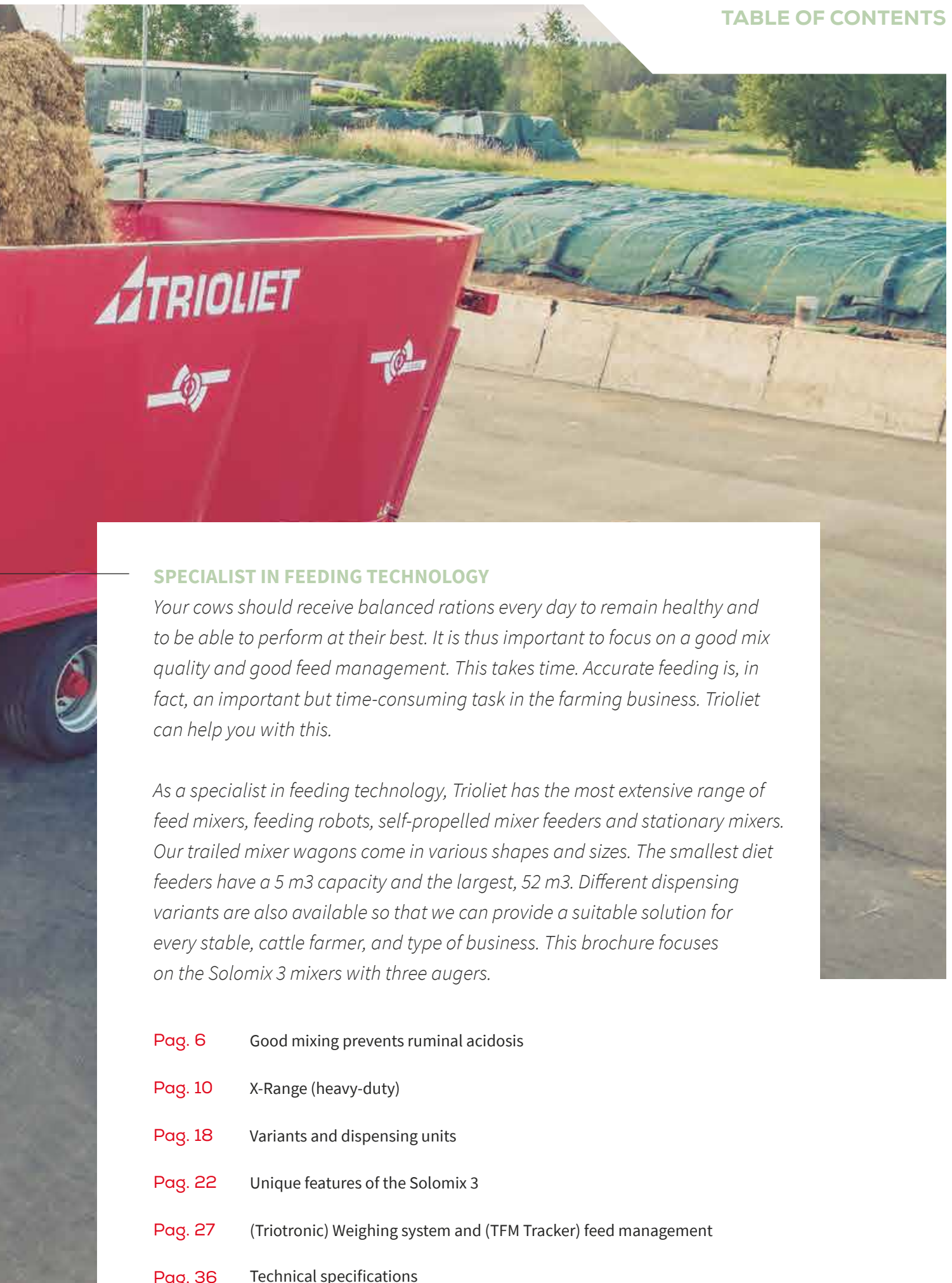

### SPECIALIST IN FEEDING TECHNOLOGY

*Your cows should receive balanced rations every day to remain healthy and to be able to perform at their best. It is thus important to focus on a good mix quality and good feed management. This takes time. Accurate feeding is, in fact, an important but time-consuming task in the farming business. Trioliet can help you with this.*

*As a specialist in feeding technology, Trioliet has the most extensive range of feed mixers, feeding robots, self-propelled mixer feeders and stationary mixers. Our trailed mixer wagons come in various shapes and sizes. The smallest diet feeders have a 5 m<sup>3</sup> capacity and the largest, 52 m<sup>3</sup>. Different dispensing variants are also available so that we can provide a suitable solution for every stable, cattle farmer, and type of business. This brochure focuses on the Solomix 3 mixers with three augers.*

- Pag. 6**      Good mixing prevents ruminal acidosis
- Pag. 10**     X-Range (heavy-duty)
- Pag. 18**     Variants and dispensing units
- Pag. 22**     Unique features of the Solomix 3
- Pag. 27**     (Triotronic) Weighing system and (TFM Tracker) feed management
- Pag. 36**     Technical specifications



The Solomix 3 mixer with three vertical augers is a true powerhouse. It is specially developed for cattle farmers who wish to process large quantities of feed in a short span of time. With the largest Solomix 3 version, you can effortlessly deliver over 20 tons of feed in half an hour. The feed mixes rapidly to form a homogeneous ration. Dispensing is smooth and even, thanks to the large discharge doors, wide dispensing unit and the unique Twin Stream double auger wings.

The Solomix 3 is available in 27 to 52 m<sup>3</sup> capacities, with dispensing possible from the front, side or back of the wagon.

#### MAIN FEATURES:

- ✓ Large mixture and discharge capacity
- ✓ Perfect mixing result thanks to unique mixing tub design
- ✓ Standard equipped with reduction gearbox\*

\* Excepting the Solomix 3 3000 model.



# EFFORTLESSLY DISCHARGE OVER 20 TONS OF FEED IN HALF AN HOUR



## GOOD MIXING PREVENTS RUMINAL ACIDOSIS

Are you looking for a mixer wagon with sufficient capacity to provide your cattle with a balanced ration every day? Then it is important that the machine does what is supposed to do; mix well. A well-mixed ration means the cows cannot be selective, receiving all the nutritional values as calculated by the feed consultant. Research shows that selection behavior by cattle is one of the main causes of ruminal acidosis and related health problems. Mixing well can prevent these problems.

## MIXES VERTICALLY AND HORIZONTALLY

Our feed mixers have an optimal mixing performance thanks to the special shape of the mixing tub and the unique Twin Stream augers. The mixer wagons are designed to achieve the best mixing result. The feed is transported horizontally through the mixing tub thanks to special, patented triangles in the tub, going from one mixing chamber to the other and back again. In addition, thanks to the unique shape of the augers, the feed is pushed up and then lowered by gravity. The feed is therefore propelled both vertically and horizontally through the mixing tub.

This so-called Dual Flow principle results in homogeneous mixing. In conjunction with the self-sharpening auger knives in the right positions, obtaining a good mix is now child's play, even with round or square bales or compact feeding. The two symmetrical auger wings and integrated discharge doors, without sharp edges behind which feed could linger, ensure a fast and even discharge, even for smaller volumes.

- ✓ Homogeneous mixing result
- ✓ Self-sharpening auger knives
- ✓ Even discharge



*Check out our online blog for a video of the Dual Flow principle. [www.trioliet.com/en/blog\\_stories](http://www.trioliet.com/en/blog_stories)*





# GOOD MIXING PREVENTS RUMINAL ACIDOSIS





Here you can see a new auger knife and a worn auger knife.

### SHARP AUGER KNIVES ARE IMPORTANT FOR A GOOD MIXING RESULT

Our Trioform auger knives have a unique shape that helps them stay sharp longer. In addition, they are mounted horizontally on the auger so that they deliver optimum cutting performance with as little resistance as possible. The patented Trioform blades not only mix better but also demand less power. This benefits the lifespan of the equipment and saves fuel. Therefore, check regularly that the blades are still in good condition and replace them in time. Above you can see a new auger knife and a worn auger knife.

The edges of the worn, upper blade are clearly dulled. This knife can no longer process the feed properly. For an optimal mix, we advise you to check the auger knives once a month. It is also important to place the blades in the right positions on the auger. Ask your dealer or consult the instructional video on our website for the best knife positions:

**[www.trioliet.com](http://www.trioliet.com)**



Read dairy farmer Delisse's story at [www.trioliet.com/en/blog\\_stories](http://www.trioliet.com/en/blog_stories).



## AVOID FEED SELECTION WITH THE CORRECT LOADING ORDER

The order in which the various components are loaded into the mixer wagon is usually determined by farmyard logistics. If the concentrate silos are located next to the barn where the mixer is parked, most cattle farmers will start loading the feed and then the maize, grass or other components. However, for good mixing results, it is important to follow a specific loading order. Generally: 'from long and dry to short and wet'. First straw and hay, then grass. Only when the long, rough components are properly cut up should finer feed components be added, such as cereals, minerals and

proteins, then the wet by-products such as brewer's waste or beet pulp, maize and finally, any water or other liquids. Components that need to be cut well must be loaded first.

Also, make sure that the mixing tub is not too full. Ideally you should fill it no more than ten centimeters below the rim. Overloading the mixer wagon has a negative effect on the mixing time and mixing quality.



Watch the instructional film "How do I optimize my mixer feeder" at [www.trioliet.com](http://www.trioliet.com)



## WEAR STRIP FOR MORE STABILITY AND EXTENDED SERVICE LIFE

Our feed mixers are developed and assembled at the factory in Oldenzaal (The Netherlands). It's not for nothing that we are famous for our robust machines and their long service life. Our mixers are equipped with a wear strip at the bottom of the mixing tub, where the pressure on the wall is at its greatest. This reinforced steel strip ensures greater stability

and a longer service life. Especially with the relatively large Solomix 3 mixers that are often used intensively, this wear strip is an important component, guaranteeing a robust construction that will wear out less quickly. It is precisely these details that make Trioliet feed mixers so durable, allowing you to enjoy them for as long as possible.



### X-RANGE

The Solomix 3 (36-52 m<sup>3</sup>) series has a special heavy-duty version, the X-Range. The robustly built X-Range series combines the best mixing quality with the highest discharge capacity and lowest Total Cost of Ownership (TCO). The X-Range is extremely well suited for intensive use under harsh conditions. For instance, the X-Range Heavy-Duty version is often used on farms with over 1,000 cows.

### X-Range mixer wagons are equipped with:

- ✓ Heavy-duty 1000 RPM drive line;
- ✓ Standard 22 mm/25 mm Long Life “Quick Mix” augers;
- ✓ Mixing tub with 10 mm wall thickness and 15 mm wear strip;
- ✓ Heavy-duty chassis. The sturdy tridem bogie is designed to support heavy loads day in and day out.



## LIGHT MIXER WAGON WITH LOTS OF CAPACITY

Whereas in some countries a feed mixer will be in use up to 12 hours a day, this is not the case for many (family) farms. However, more and more companies with two hundred to four hundred cows prefer to feed one or two times a day. To meet the demands of these companies, Trioliet has developed 27 m<sup>3</sup>, 30 m<sup>3</sup> and 34 m<sup>3</sup> 3-auger mixers. The machines are low in construction, with a low loading height, but have a huge capacity. With these Solomix 3 variants, it is possible to feed a large amount of cattle in a short amount of time with a relatively light tractor (140 – 160 hp). By default, the mixer wagons are delivered with a switchable gearbox with cooling system. The wagons also meets European requirements for road transport.



## FEED LOTS OF CATTLE IN A SHORT AMOUNT OF TIME







***Trioliet would like to -  
contribute to a better  
environment for both  
people and animals***



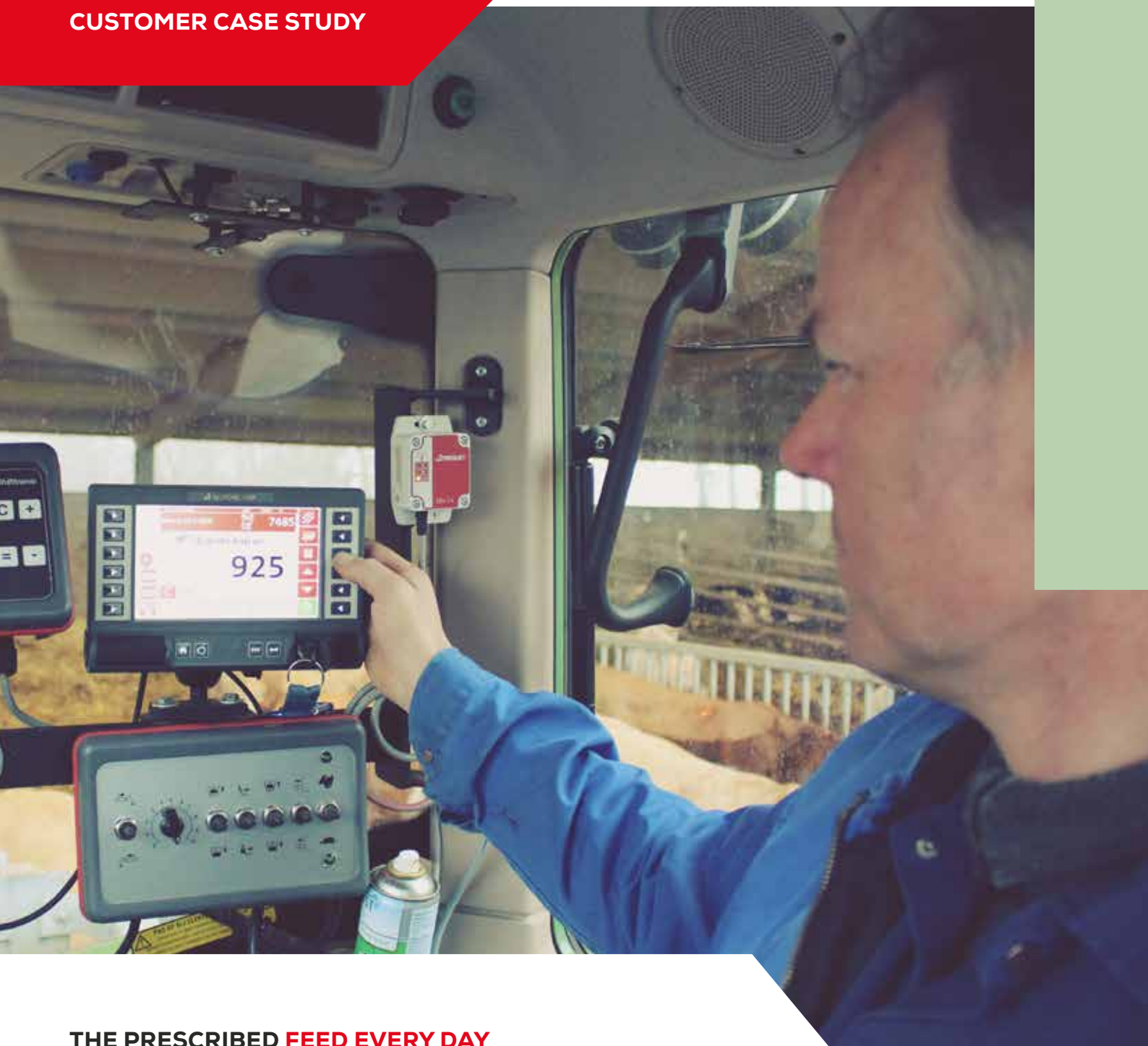

## THE PRESCRIBED **FEED EVERY DAY**

Cattle farmer Gerard Arkink uses a Solomix 3 3000 VLH-B to feed over 500 head of beef cattle. He describes it as “the Major League of mixer wagons”.

He has been using a Trioliet mixer for two years now. He has also looked at other brands, but the TFM Tracker feed management program was the deciding factor. “In addition to the TFM Tracker feed management program, we also liked the innovative, well-designed technology and extra features.

For example, it is very useful that I can set the mixing time via the headland management system of the tractor. As a cattle farmer, I spend a lot of time compiling the most optimal ration, and I want that to be 100% homogeneous without structural degradation.

It is very important that we use the prescribed feed, and that we do this consistently each day. Only then can we gain the best possible results.”



# THE MAJOR LEAGUE OF MIXER WAGONS

Gerard Arkink | cattle farmer

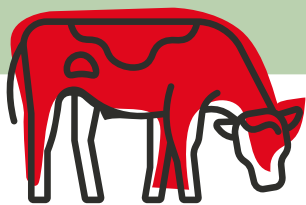

**500 beef cattle**



For more stories, check out our blog

[www.trioliet.com/blog\\_stories](http://www.trioliet.com/blog_stories)

## SHIFTRONIC



The Shifttronic is especially invaluable for the large mixer feeders with 3 augers.



### SHIFTRONIC FOR CORRECT AUGER SPEED AT THE RIGHT TIME

Large feed mixers require relatively high amounts of power and thus, fuel. The Solomix 3 Series therefore comes with a gearbox as standard\* to address the power surges occurring during start-up and loading in particular. In addition to the standard gearbox, Shifttronic 2 and 3 speed automatic gearboxes are also available. The Shifttronic automatically shifts up and down in a few stages to the optimal auger speed for mixing and discharging.

With the Shifttronic automatic gearbox, the mixer always starts up in low gear and the auger speed during mixing increases automatically for dry, lightweight feed components, or goes down for heavier mixtures. During discharging, it shifts up again automatically in order to quickly and fully empty the wagon.

The shifting moments are preprogrammed based on the specific ration weight. That means the Shifttronic always rotates at optimum torque, saving considerably on fuel consumption and extending the service life of the mixer wagon's drive line and the PTO coupling for the tractor. Especially for the large mixer feeders with 3 augers, the Shifttronic is invaluable.

\* Excepting the Solomix 3 3000.

### ADVANTAGES OF THE SHIFTRONIC:

- ✓ Automatic up- and down-shifting
- ✓ Extends the service life of the drive line and the PTO coupling
- ✓ Saves on fuel





**THE SHIFTRONIC  
SAVES ME AN  
HOUR OF TIME  
EACH DAY AND  
25% IN FUEL**

*Hans Luijckink | cattle fattening farmer*



## CONFIGURATIONS



## CONFIGURATIONS

The Solomix 3 comes in three configurations. A list of the various abbreviations:

- VLH** Discharging unit at the front of the machine. Wheels under the mixing tub.
- VLX** Heavy-Duty version of the VLH. Discharging unit at the front of the machine. Wheels under the mixing tub.
- ZK(X)** Dispensing through discharge doors at the side or back of the mixing tub. X=Heavy-duty version.
- P ZK(X)** Dispensing through discharge doors at the side and a straw blower. X = Heavy-Duty version.

## DISCHARGING UNITS

The discharge units on our mixer wagons are relatively large. This promotes a good flow of feed and increases the discharge capacity.

- B:** **Cross conveyor belt** with or without side-shift
- K:** **Cross conveyor chain** with or without side-shift
- C:** **Curved cross conveyor chain** with side-shift
- S:** **Cross conveyor chain** with a retractable extension chain
- ZK:** **Side discharge doors** with discharge chute





ZK

The most suitable discharge unit will depend on the conditions at your farm, of course. For example, the width of the feeding alley can affect your choice. We have an appropriate feed mixer for every cattle farmer and every situation, whether you have a wide or narrow feeding alley, whether you use a conveyor belt or troughs to feed and for any type of stable. Tell us your needs





### FEEDING IN TROUGHS

We have special discharge units with side-shift or retractable extension chain for feeding in troughs. This allows the cross-conveyor belt or chain to be extended so that it is possible to discharge higher and further from the machine.

### SOLOMIX P3 WITH STRAW BLOWER

The Solomix P is a feed mixer with a straw blower. The powerful mechanically driven straw blower is placed at the front of the mixer wagon and can spread straw up to 25 meters in depth. By default, the mixer is equipped with an electric remote control to operate all functions comfortably from the tractor cabin. To minimize dust emissions, a spray unit with water tank is available as an option.

The blower casing is placed directly on the mixing tub for fast processing of large quantities of straw. This also allows the mixer wagon to be more compact.

This blower is driven by multiple belts, so that the PTO shaft needn't be switched on and off and the blower can run out freely after the work is done, without loading the drive line unnecessarily. Furthermore, the straw blower is equipped with removable blades for easy maintenance. The blower's discharge chute can be controlled both horizontally and vertically to spread the straw in any desired area of the stable.





## MAGNET IN MIXER WAGON PREVENTS HEALTH PROBLEMS

Each year, an estimated 12,000 cows in the Netherlands alone are injured by ingesting litter that has entered their feed. Another four thousand cows die as a result of hardware disease. Wageningen University conducted research into the effects of ingestion of stray metal pieces and concluded that it costs dairy farmers millions of euros per year in medical treatments, mortality and lower milk production. However, there is a relatively simple and inexpensive solution; magnets in the mixer feeder wagon.

### Trioliet offers three types of magnet:

1. Auger magnets on the auger blade
2. Magnet rods for a cross conveyor belt or chain
3. Magnet strip on the discharge chute near a side discharge door



YOUR ANIMALS  
DESERVE  
THE BEST



## UNIQUE FEATURES OF THE SOLOMIX 3

**Unique mixing tub for a homogeneous mixture** | Asymmetrical triangles make sure that the feed is also mixed in a horizontal direction. This delivers optimally and evenly mixed rations and rapid, uniform feed discharge.

**Large window for optimal observation of the mixing process.**

**Unique weighing system** | Three robust weighing bars ensure maximum stability. Thanks to a dual measurement per weighing bar, the weight is displayed with extreme precision. The bright LCD display is well shielded in a shockproof, waterproof housing.

**Strong, stable mixing tub** | The bottom of the mixing tub, where the pressure on the mixing chamber is greatest, is provided with a special wear strip. This ensures more stability and a longer service life.

**Shiftronic** | 2-speed or 3-speed.

**Slim, stable auger column** | The slim auger column is very stable because it is directly supported by the chassis underneath.

**Heavy-duty mechanical drive line** | The robust planetary gearboxes can handle large loads. The wagons are equipped with a mechanical drive for high efficiency and a low power requirement.

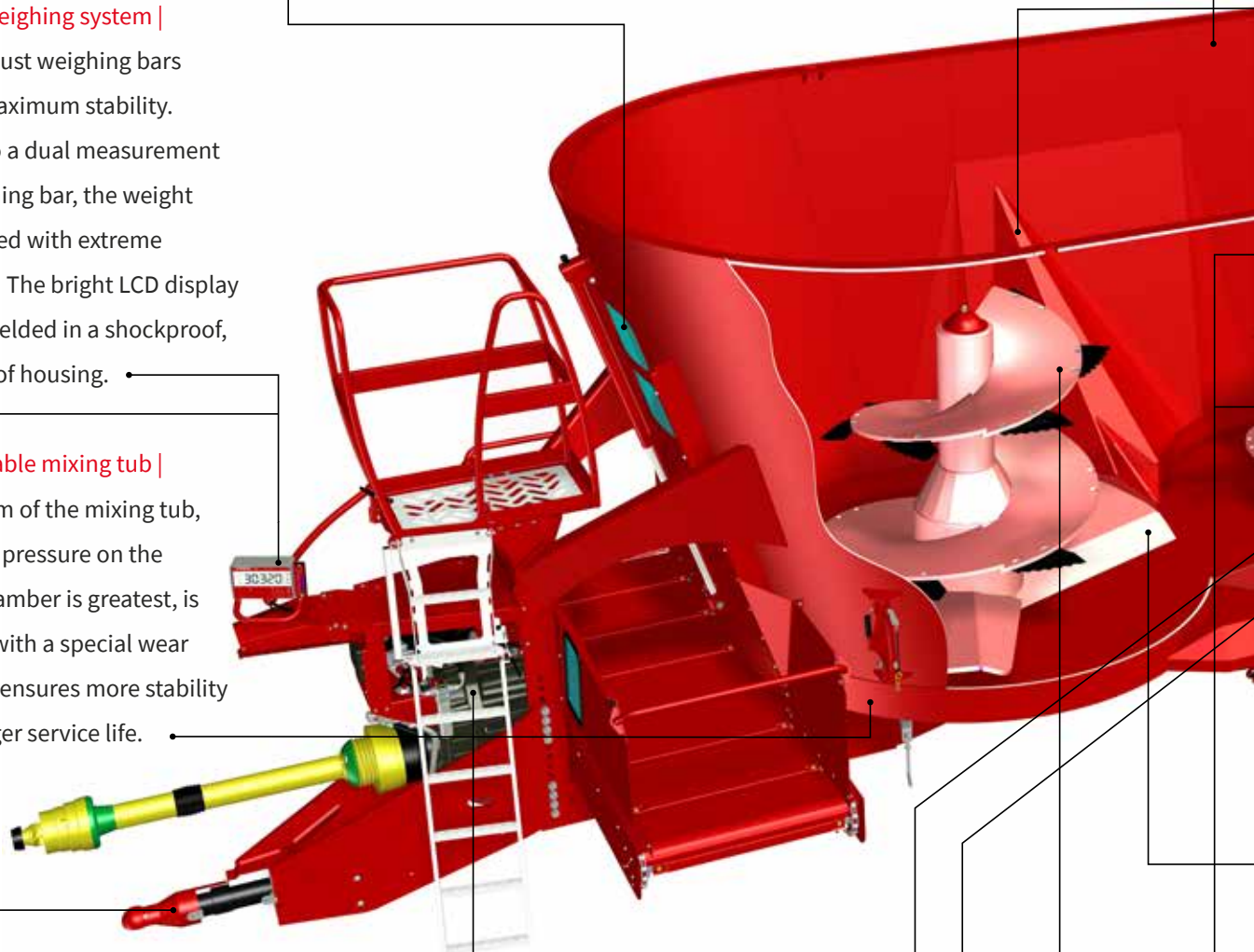



## WATCH OUR VIDEO:

"HOW TO OPTIMISE MY MIXER FEEDER" AT  
[TRIOLIET.COM](http://TRIOLIET.COM)

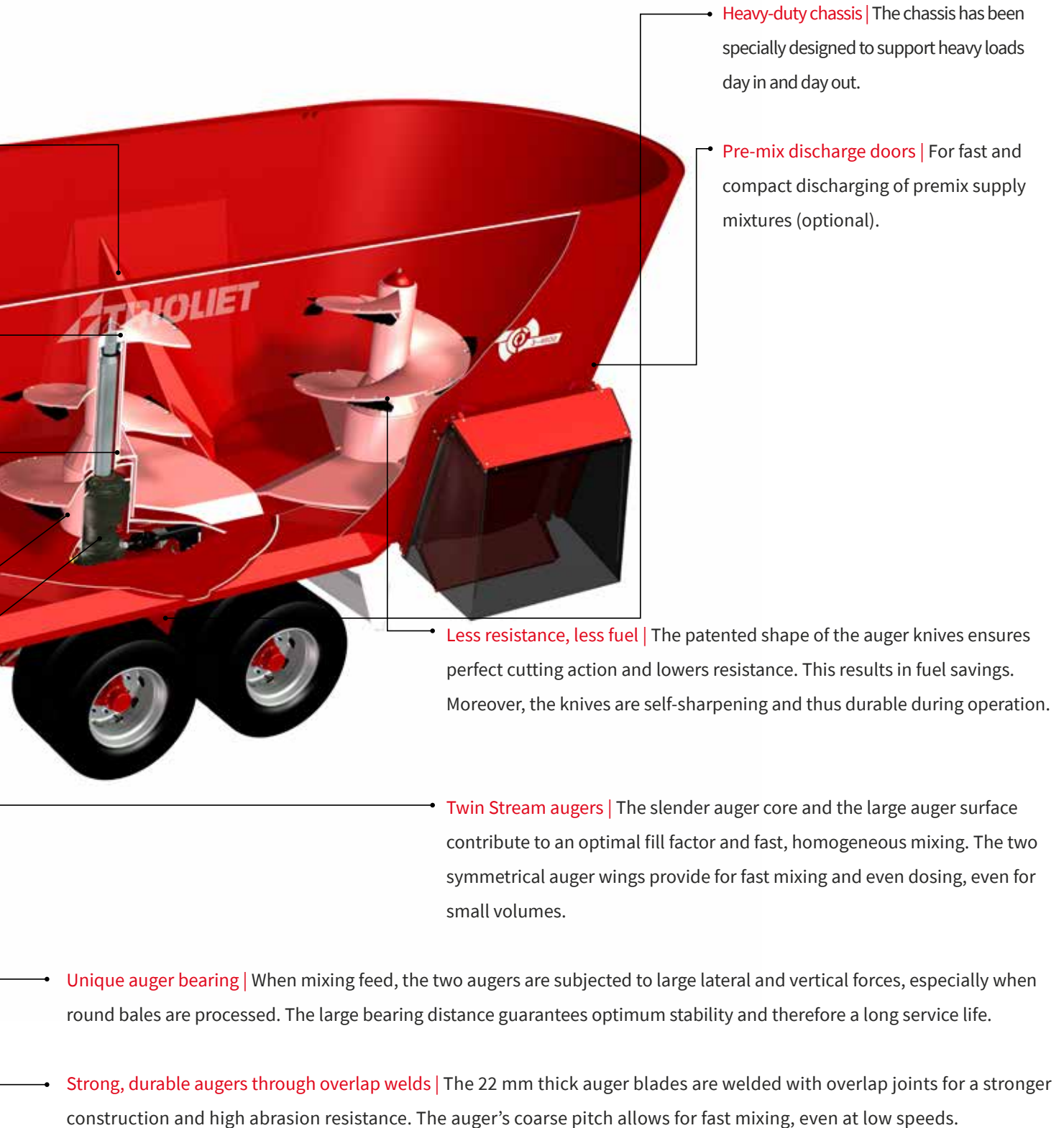

• **Heavy-duty chassis** | The chassis has been specially designed to support heavy loads day in and day out.

• **Pre-mix discharge doors** | For fast and compact discharging of premix supply mixtures (optional).

• **Less resistance, less fuel** | The patented shape of the auger knives ensures perfect cutting action and lowers resistance. This results in fuel savings. Moreover, the knives are self-sharpening and thus durable during operation.

• **Twin Stream augers** | The slender auger core and the large auger surface contribute to an optimal fill factor and fast, homogeneous mixing. The two symmetrical auger wings provide for fast mixing and even dosing, even for small volumes.

• **Unique auger bearing** | When mixing feed, the two augers are subjected to large lateral and vertical forces, especially when round bales are processed. The large bearing distance guarantees optimum stability and therefore a long service life.

• **Strong, durable augers through overlap welds** | The 22 mm thick auger blades are welded with overlap joints for a stronger construction and high abrasion resistance. The auger's coarse pitch allows for fast mixing, even at low speeds.



### PREVENT HARDWARE DISEASE

Pim Lenferink from knows that magnets can prevent a lot of injury. He feeds his 135 dairy cows with a Trioliet mixer that is fitted with auger magnets. He was not aware of this product until his dealer explained he could place magnets on the augers. It was a purchase he definitely does not regret.

He shows his ‘harvest’ on the kitchen table, picking out the most striking objects. This includes nails, barbed wire and screws. But other, sometimes indefinable, metal objects are also included in the collection. Some have extremely sharp edges and are as long as a ballpoint pen. It is clear that these objects could most certainly injure a cow.

“Within a month we collected around thirty objects”, explains Pim Lenferink.

“Every day we find sharp metal objects on the magnet. We were so impressed that we immediately installed a magnet on the second auger.”

### BIRDS COULD BE THE CULPRITS

How these metal objects enter the feed is shrouded in mystery. Pim: “They could be thrown by school children or passing motorists. But we have also heard that crows pick up these types of objects to build their nests and then drop them because they’re too heavy. Whatever it is, this collection is certainly food for thought. I didn’t know beforehand what the results would be. But I cannot imagine that other farmers are able to filter out all the sharp objects when preparing silage. After all, you can’t know what you



don't see.

People often think they will find sharp objects in grass silage, but what about the by-products and the hay and straw bales?"

Lenferink recently made a striking discovery. The magnets were covered with a thick layer of metal grit – extremely small particles of metal, most probably from a batch of purchased concentrate feed. Pim: "This doesn't immediately cause damage, but it shouldn't be in there.

We would never have been able to retrieve it without the magnet. That just goes to show how important the magnets are. As far as I am concerned, this should be a standard feature of every mixer wagon, as it saves a great deal of animal suffering."



*For more stories, check out our blog*  
[www.trioliet.com/en/blog\\_stories](http://www.trioliet.com/en/blog_stories)

# LOWER COSTS WITH FEED MANAGEMENT

*Pim Lenferink | Dairy farmer*

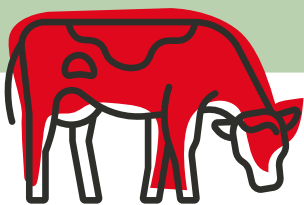

**135 dairy cows**





### GET THE MOST FROM YOUR FEED MIXER

How do I make the best use of the feed mixer and ensure an optimally mixed ration? When do I use a counter knife, how much feed can I load and how do I avoid high maintenance costs? We give some important tips in our instructional video. You will see that you can influence the mixing results and maintenance costs. When buying a Trioliet mixer you will receive this video on a USB stick, but you can also find it on our website [www.trioliet.com](http://www.trioliet.com).



Download the "Trioliet Feeding Experience" app

### LOWER COSTS WITH FEED MANAGEMENT

As a cattle farmer, you know that feed can be up to 40 percent of the cost. It is therefore important to remain critical. There is often a lot of room for improvement, even if you are already using precise amounts of feed. With good feed management, you can save more than 4% on daily feed costs.

A feed management program compares the predetermined ration with the amount of feed that is actually delivered. As a cattle farmer, you can use this data to pinpoint any deviations and thus, where improvements are possible. You are given insight into the forage and feed concentrate costs compared to yield. These insights will help you to adjust where necessary.



# SAVE 4% ON DAILY FEED COSTS

## TRIOTRONIC WEIGHING SYSTEM

The Triotronic electronic weighing device is an indispensable tool in larger cattle farms to enable accurate feeding of the herd. Depending on the type of mixer wagon, the different Triotronic weighing devices are equipped with three or five robust weighing bars that provide maximum stability. Each weighing bar provides two weight measurements. The calculated average ensures a reliable weighing result. This also avoids errors due to peak loads.

## WEIGHING INDICATORS

The weighing system comes standard with the Triotronic 2810V weighing indicator. This weighing indicator, equipped with a bright LCD display, shows the weight loaded into the mixer wagon. The programmable version, the Triotronic 3610V, displays the weight per feed component, while maintaining the total weight. It is also possible to enter a target weight per component. A warning signal indicates when the target weight is reached.

The Triotronic 7600T is a programmable weighing indicator with touchscreen for the tractor cabin. The touchscreen can be used to browse easily through the feed data and to switch quickly between components, rations, and animal groups. The large color display provides a perfect display of weight and ration information. Changes to the ration can be implemented quickly and easily from the tractor.



Remote display on mixer wagon



Triotronic 2810V weighing indicator



Triotronic 7600T weighing indicator with touchscreen

The data transfer from the programmable weighing indicators to the TFM Tracker feed management program goes through a USB stick or WiFi.

There is also a version available for reading from a distance; the large remote display. This scrolling LED display is mounted to the front of the mixer feeder and allows the weight to be easily read from afar when loading with a telescopic handler, wheel loader or tractor.

## CAB CONTROL

In addition to weighing computers on the mixer wagon, it is also possible to read the weight from the loading vehicle with a Cab Control indicator. With Cab Control you always have a wireless view of the current weight, even for the silage pit or concentrate silos.

### We offer three Cab Control (CC) options:

- 1. CC 300 App.** With this app on your smartphone or tablet, you can use WiFi to connect to the weighing system on your feed mixer. You can see the real-time weight on your phone or tablet in a radius of 90 meters around the mixer wagon. Suitable for Android and iOS.
- 2. CC 400 View.** The CC 400 View indicator allows you to validate the weighing system on the mixer wagon remotely, and to switch between net/gross and total weight (counting function). With a programmable weighing system, you can also switch between the different components.
- 3. CC 500 Touch.** With the CC 500 Touch indicator, you can validate the programmable weighing system on the mixer, switch between net/gross and total weight, select a programmed ration and start and switch between the different components. In combination with a Triotronic 7600T weighing computer, the CC 500 Cab Control gets the same clear screen layout as the Triotronic 7600T with complete ration and component names on a backlit color touchscreen.



CC 300 app



CC 500 Touch



# GET THE MOST FROM YOUR MIXER FEEDER WAGON



# TFM TRACKER FEED MANAGEMENT

*Get a grip on your feed costs*



*The TFM Tracker Feed management program provides a great deal of valuable information. This includes the rations, dry matter uptake and load precision as well as the residual amount of feed and the stocks of forage and feed concentrate feed based on the rations used.*

Graphs instantly provide an overview of the feed costs and the average over a given period. In addition, it is also possible to link certain feed management programs to other business management systems. In this case, for example, the feed data is linked to the milk production and the feed efficiency can be determined easily. In short, it gives answers to one of the most important questions “What is the return?”.

## **Trioliet offers different TFM Tracker versions:**

- ✓ **TFM Tracker™ Dairy** feed management for dairy farmers (Basic, Lite, Pro and Pro+)
- ✓ **TFM Beef Tracker™ feed** management for beef farmers (Pro and Pro+)
- ✓ **TFM Tracker™ Contractor** feed management for contract workers (Pro+)

## **TFM TRACKER™ DAIRY**

The Basic version is ideal for cattle farmers who want to take a first step in the field of feed management. This is a simple, straightforward system that allows you to program the feed components, rations and animal groups into the computer and then transfer the data to the diet feeder’s weighing computer. The reports show at a glance how much feed is actually loaded and fed relative to the planned ration and the dry matter uptake per cow. TFM Tracker™ Basic can be easily upgraded to Lite, Pro or Pro+ for functions such as inventory management, feed cost overview and the link to business management systems.





Do you know what your animals are eating?

### TFM BEEF TRACKER™

TFM Beef Tracker offers many possibilities for beef farmers. The feed management system can track animals by group, generate reports using daily weight gain, and report on feed costs per increased weight. The system also has the ability to generate dry matter feed conversion and create a total summary report when delivering animals. A nice addition is the module for the feed dispenser score.

### TFM TRACKER™ CONTRACTOR

TFM Tracker Contractor is specifically designed for contractors to manage and control the feed process for multiple customers. The workflow is easy to check, as it will generate all the feed times and weights. Based on these feed times and quantities, invoicing per customer is a breeze.



### SMART SOLUTIONS

*Our feeding systems are developed and assembled in our factory in the Netherlands. Quality and innovation are our top priorities. It's not for nothing that we are famous for our robust machines and their long service life.*

You are guaranteed a quality product when you choose Trioliet. We excel in technical ingenuity. We don't have more than sixty patents to our name for nothing. Our R&D department not only consists of highly qualified engineers with an understanding of mechanical engineering. They also have a lot of affinity with the agricultural sector. That means we are always developing from the perspective of the user. New machines are thoroughly tested before they go into production.

Every day, about 250 employees work on the development, assembly and sale of our feed systems both at our headquarters in the Netherlands and in the field, at home and abroad. About 85% of our machines are exported to more than 50 countries. You can find Trioliet feed mixers in Germany, the United States, Canada, Mexico, Uruguay, Chile, Saudi Arabia, France, Ireland, China, Norway, Russia and Australia, to name but a few.





## GREEN LABEL

Our aim in everything we design, and produce is to be of service to the cattle farmer. Relief of labor, time and fuel savings, a healthy herd and optimum mixing quality are just some of the priorities that we focus on. Naturally, we also pay careful attention to the environment and to living conditions. The products that make a significant contribution to sustainability are awarded the Green Label quality mark. Take, for example, the fuel-saving Shifttronic gearbox, the Trioliet cutting unit, or the dust-reducing water injection system on our straw blowers. You can recognize the Green Label quality mark by the sticker on the wagon.







A photograph of a red tractor in a field. In the foreground, there is a large pile of brown hay or straw. To the left, the head of a black cow is visible. The background is a blurred green field with trees. The text is overlaid on the right side of the image.

***A well-mixed ration -  
has a major impact  
on the general health  
of the cow***

# SOLOMIX 3 VLH

Front discharging with high discharge



## TECHNICAL SPECIFICATIONS FOR THE SOLOMIX 3 VLH

Solomix 3 VLH	2700L	3000	3000L	3400
Capacity m3	27	30	30	34
Length m	9.99	9.15	10.05	10.13
Width m	2.54	2.54	2.54	2.54
Height m	2.90	3.30	3.10	3.35
PTO RPM	1,000	540	1,000	1,000
Tractor power requirement HP (kW)	140 (103)	130 (95)	150 (110)	160 (117)
Tire size (4x)	435/50 R 19.5	435/50 R 19.5	435/50 R 19.5	435/50 R 19.5

Wagons in alternative heights are available on request.

### YOU CAN CHOOSE FROM A RANGE OF DISCHARGE UNITS:

- B: Cross conveyor belt*
- K: Cross conveyor chain*
- C: Curved cross conveyor chain with side-shift*
- S: Cross conveyor chain with a retractable extension chain*



# SOLOMIX 3 ZK

*With side discharge doors*



## TECHNICAL SPECIFICATIONS FOR THE SOLOMIX 3 ZK

<b>Solomix 3 ZK</b>	<b>2700L</b>	<b>3000</b>	<b>3000L</b>	<b>3400</b>
Capacity m3	27	30	30	34
Length m	9.38	8.53	9.44	9.51
Width m	2.54	2.54	2.54	2.54
Height m	2.90	3.30	3.10	3.35
PTO RPM	1,000	540	1,000	1,000
Tractor power requirement HP (kW)	140 (103)	130 (95)	150 (110)	160 (117)
Tire size (4x)	435/50 R 19.5	435/50 R 19.5	435/50 R 19.5	435/50 R 19.5

Wagons in alternative heights are available on request.

# SOLOMIX 3 VLX

Front discharging in heavy-duty version



## TECHNICAL SPECIFICATIONS FOR THE SOLOMIX 3 VLX

Solomix 3 VLX	3600	4000L	4600	4600 TR
Capacity m3	36	40	46	46
Length m	10.10	10.75	10.83	10.83
Width m	2.75	2.97	2.97	2.97
Height m	3.38	3.28	3.61	3.54
PTO RPM	1,000	1,000	1,000	1,000
Tractor power requirement HP (kW)	177 (130)	191 (140)	204 (150)	204 (150)
Tire size	(8x) 275/70 R 22.5	(8x) 275/70 R 22.5	(8x) 315/80 R 22.5	(6x) 435/50 R 19.5

Wagons in alternative heights are available on request.

### YOU CAN CHOOSE FROM A RANGE OF DISCHARGE UNITS:

- B: Cross conveyor belt*
- K: Cross conveyor chain*
- C: Curved cross conveyor chain with side-shift*
- S: Cross conveyor chain with a retractable extension chain*



# SOLOMIX 3 ZKX

*With side discharge doors in heavy-duty version*



## TECHNICAL SPECIFICATIONS FOR THE SOLOMIX 3 ZKX

Solomix 3 ZKX	3600	4000L	4600	4600 TR	5200 TR
Capacity m3	36	40	46	46	52
Length m	9.51	10.17	10.25	10.25	10.89
Width m	2.66	2.97	2.97	2.97	2.97
Height m	3.38	3.28	3.61	3.54	3.61
PTO RPM	1,000	1,000	1,000	1,000	1,000
Tractor power requirement HP (kW)	177 (130)	191 (140)	204 (150)	204 (150)	240 (176)
Tire size	(8x) 275/70 R 22.5	(8x) 275/70 R 22.5	(8x) 315/80 R 22.5	(6x) 435/50 R 19.5	(12x) 315/80 R 22.5

Wagons in alternative heights are available on request.

# SOLOMIX P3 ZK(X)

*With straw blower and side discharge doors*



## TECHNICAL SPECIFICATIONS FOR THE SOLOMIX P3

<b>Solomix P3</b>	<b>3000 ZK-T</b>	<b>3600 ZKX-T</b>
Capacity m3	30	36
Length m	9.04	9.76
Width m	2.54	2.66
Height m	3.30	3.40
PTO RPM	540	1,000
Tractor power requirement HP (kW)	130 (95)	177 (130)
Tire size	(4x) 435/50 R 19.5	(8x) 275/70 R 22.5





## OPTIONS

- |     |                                       |     |  |
|-----|---------------------------------------|-----|--|
| 1.  | Camera on the back of the mixer wagon | 12. | Pre-mix discharge door                             |
| 2.  | Electric remote control               | 13. | Adjustable extension chain                         |
| 3.  | Bowden cable control                  | 14. | Top knife  |
| 4.  | Rubber hay ring                       | 15. | LED lighting                                       |
| 5.  | Steel hay ring                        | 16. | Spray unit for straw blower                        |
| 6.  | Auger magnet                          | 17. | Shifttronic 2-speed, under load switchable gearbox |
| 7.  | Hinged magnet set for discharge unit  | 18. | Shifttronic 3-speed, under load switchable gearbox |
| 8.  | Automatically hinged discharge chute  | 19. | Hydraulic support                                  |
| 9.  | Speed control discharge unit          | 20. | Draw bar for tridem undercarriage                  |
| 10. | Electric position sensor              |     |  |
| 11. | Adjustable elevating conveyor         |     |  |

## ABOUT TRIOLIET

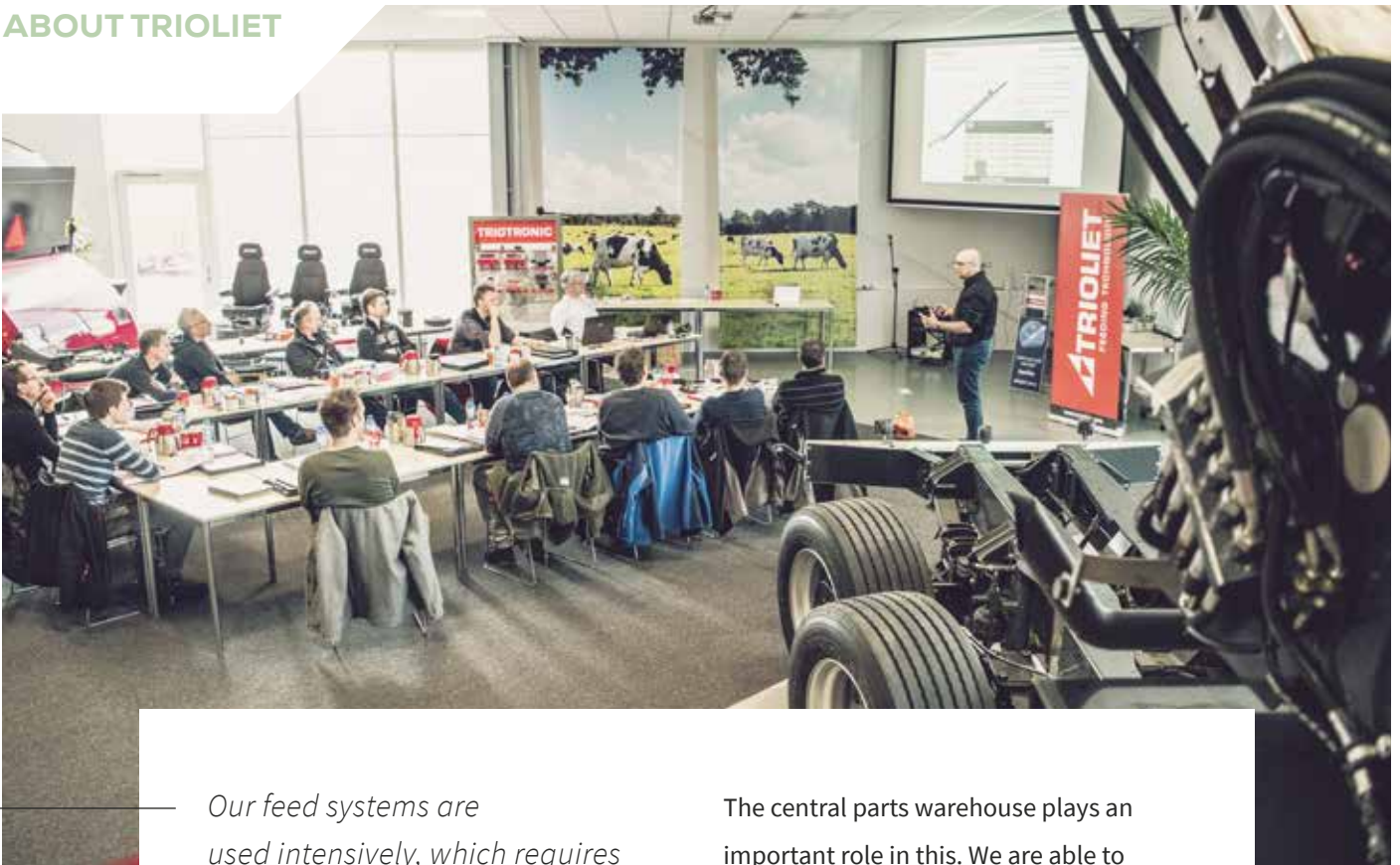

*Our feed systems are used intensively, which requires periodic maintenance. To be able to quickly service your requirements, we have an extensive worldwide network of dealers. They are ready to advise and assist as required.*

From our head office in the Netherlands, our own service engineers and fitters offer support to the dealers.

The central parts warehouse plays an important role in this. We are able to supply (spare) parts all over the world within 24 hours both from the head office in the Netherlands and from our warehouses in the United States and China. Our dealers periodically undergo training so they are always up to date with the most recent developments. Fitters and sellers come to our head office from all over the world for technical and commercial training sessions at the Trioliet Training Centre.







As you can see, we are a total supplier of premium feed technology. Every day thousands of cows all over the world are fed with our machines. In just over 65 years our family business has grown into a global player. We view it as our duty to provide sustainable premium solutions around the world for the mechanised and automated feeding of cattle on professional farms. That means that designing new solutions and optimising existing technologies are our highest priorities. We are able to offer made-to-measure solutions for cattle farms throughout the world. To do this, we draw on our extensive product range. We hope to be able to be of service to you too.

**Robert Liet**

A handwritten signature in blue ink, appearing to read 'Robert Liet'. The signature is stylized and fluid.



**TRIOLIET.COM**

Trioliet. Invents for you.

**TRIOLIET BV**

Kleibultweg 59

NL-7575 BW Oldenzaal

The Netherlands

T (+31) 541 - 57 21 21

F (+31) 541 - 57 21 25

info@trioliet.com